

✓ High Temperature Resistance up to 200 °F

The Onyx Collection boasts exceptional heat resistance, enduring temperatures of up to 200 °F. This surpasses standard vinyl options, typically rated for 162 °F, ensuring reliable performance for windows and doors, particularly in hot climates.

✓ Structurally Stable

Our engineering team guarantees that the Onyx profile offers optimal resistance to window warping. Factors like intense heat, prolonged sun exposure, and moisture can cause a profile to expand or shrink. Leveraging advanced proprietary technology, The ONYX Collection ensures consistent, dependable performance in all conditions.

✓ Lasting Upscale Color

The Onyx Collection retains its color despite environmental factors such as UV light, temperature changes, and varying conditions. Its distinct onyx shade matches well to many aluminum windows and doors. The color brings a modern aesthetic to your home or building providing an upscale look that stands above traditional white vinyl.



Onyx Collection

Willer Windows & Doors is excited to announce The Onyx Collection, expertly engineered from the inside out. This collection showcases a sophisticated flat-black color profile, developed with an innovative new vinyl composition that ensures lasting beauty even in temperatures reaching 200°F.

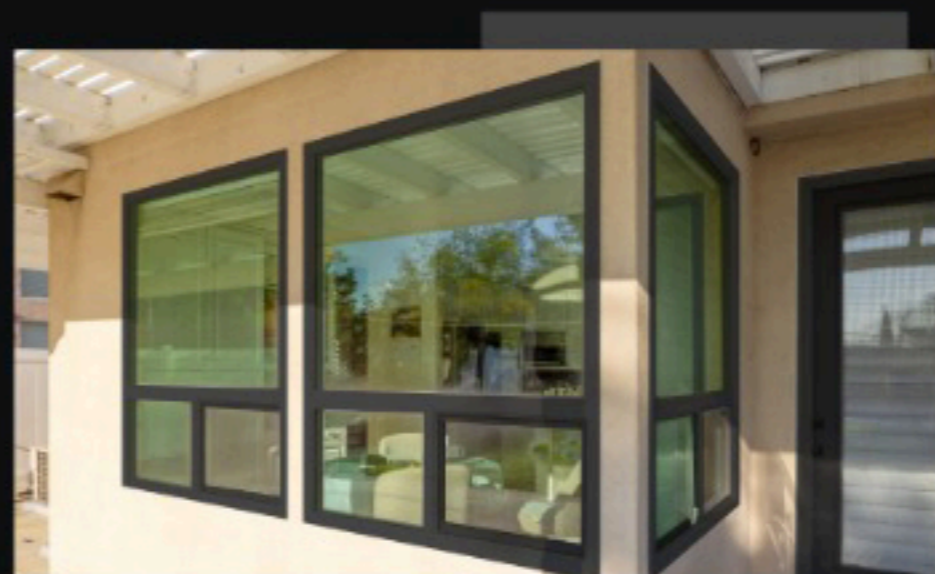

Contact us for more information!

Business Hours

📍 San Diego, CA

Mon. - Fri. 8:00 am - 5:00 pm
Saturday. Closed
Sun. Closed!

Hardware Solutions LLC

1690 W Frontage Rd,
Chula Vista, CA 91911

Direct: (619) 737.9999 | Text: (619) 271.2222

Fax: (619) 271-2222
sales@glahs.com



Get your free quote. Contact us by phone, email, fax or visit us in person.



Grid Configurations

Grid Between the Glasses

Easier for you to clean the surface of the glass

Flat Grids Size: 3/4"
Sculptured Grid Size: 1"

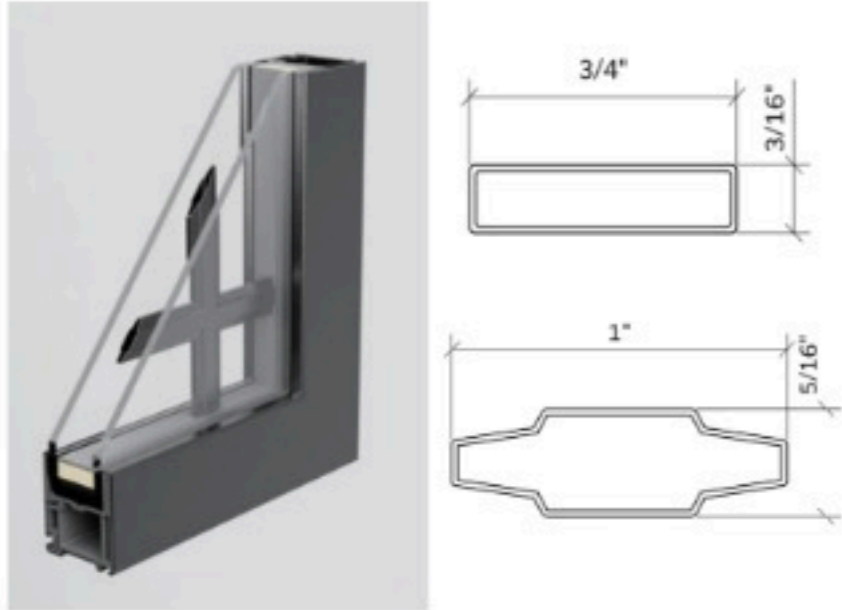

Onyx windows offer several benefits:

Aesthetic Appeal: Sleek, modern design with a distinctive look.

Durability: High-quality materials that withstand harsh conditions.

Energy Efficiency: Advanced glazing reduces heating and cooling costs.

Low Maintenance: Resistant to staining and corrosion.

Privacy: Tinted or frosted options for increased privacy.

Security: Enhanced locking mechanisms and impact-resistant glass.

Noise Reduction: Better insulation for a quieter indoor environment.

Onyx collection window styles

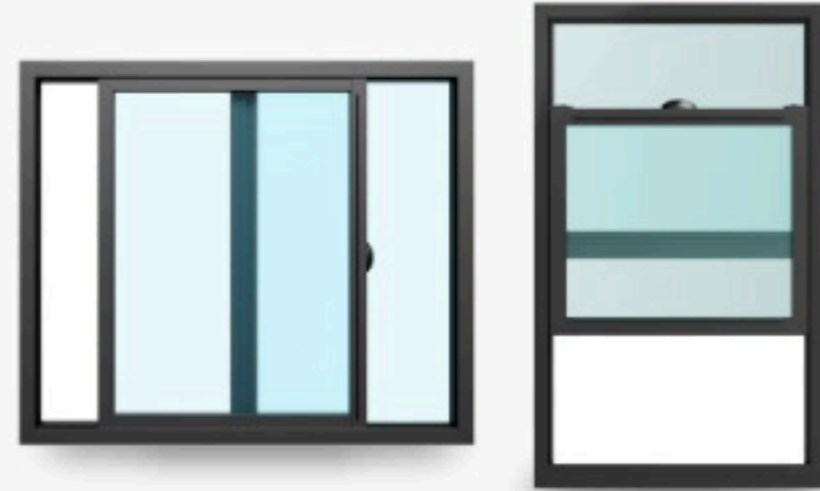

Sliding Window

Single Hung

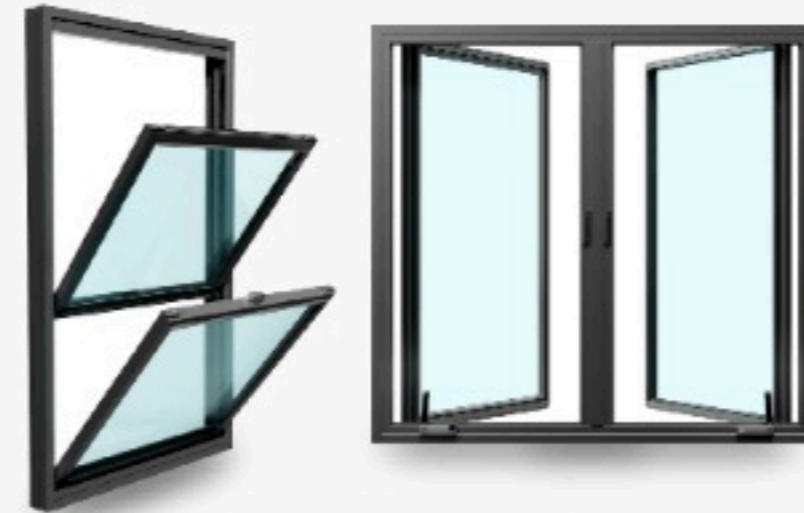

Double Hung Window

Casement Window



Awning Window

Picture Window

Onyx collection door styles



Sliding Door

Swing Door

Window Frames



Retrofit Frame

For replacement applications. The replacement flange allows for convenient installation with no need to break out stucco.

Nail-On Frames

Nail-on frame allows for targeted installation in new construction applications and is available in 1" and 1-3/8" setback.

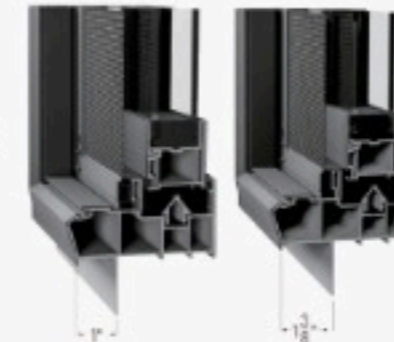

Dual-Pane Glass

Two layers of glass separated by super spacer.

High quality Cardinal Glass

Offers improved insulation compared to single-pane glass.

Filled with Argon Gas between the panels.

Provides better soundproofing and energy efficiency.

Generally more cost-effective than triple-pane glass.

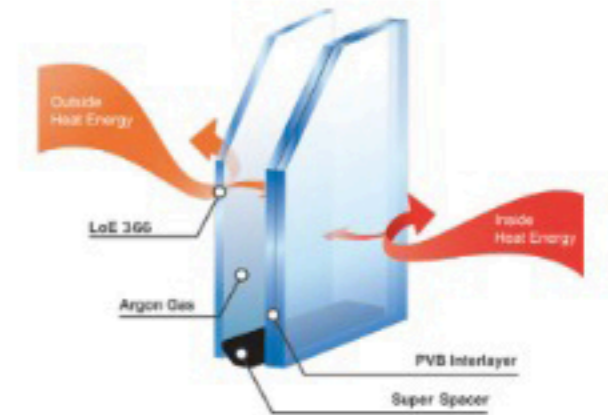

Triple-Pane Glass

Three layers of glass separated by two super spacers.

High quality Cardinal Glass

Offers even higher levels of insulation and energy efficiency.

Filled with Argon Gas between the panels.

Provides superior soundproofing and thermal performance, especially in extreme climates.

* Some vinyl series cannot be installed with triple pane. Please contact our sales team for more information.

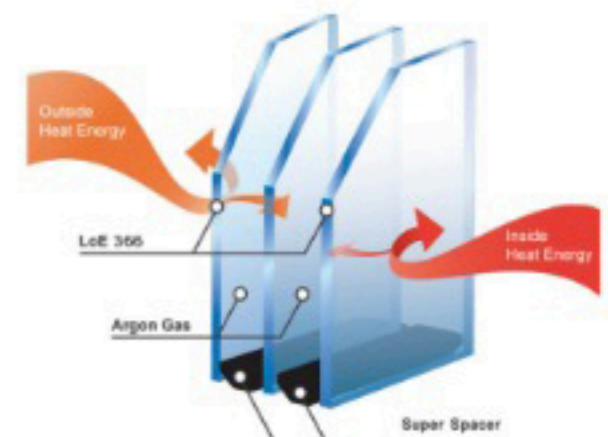



Why buy your Vinyl windows with us?

Not All Vinyl is the same: You will not have to worry that your White Window will turn Yellow over the years since the quality of the material of our windows is 100% Vinyl (u-PVC) Which means that your Window will always be White. Another feature of our vinyl is its Light (UV) additive and weathering stabilizers that prevent the window from discoloration.

IG Unit: The combination of LowE3 glass and Duralite Spacer is a combination that will help you when the heat temperature is very high, Lowe3 glass is formulated to reject solar heat without affecting the view of your Window, it will maintain your indoor cooler and comfortable.

Customer Service: Our Friendly Customer Service is the best; we will help you find the best solution that suits your window expectations.

Fast Service: Our delivery time is the best since we combine speed in delivery and quality in our products, each product is carefully reviewed before being delivered.



Window Frames



Retrofit Nail-on Block

Patio Door Frames

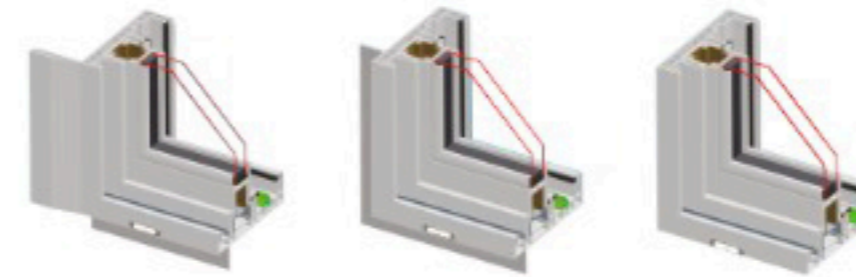

Retrofit Nail-on Block

Window Configurations



Sliders Single Hung Double Hung



Special Link Casement Picture-Fix



Arch Bay Windows Garden Windows



Awning Windows Shape Windows

Sliding Patio Doors



French Swing Doors



Shower and Closet Doors

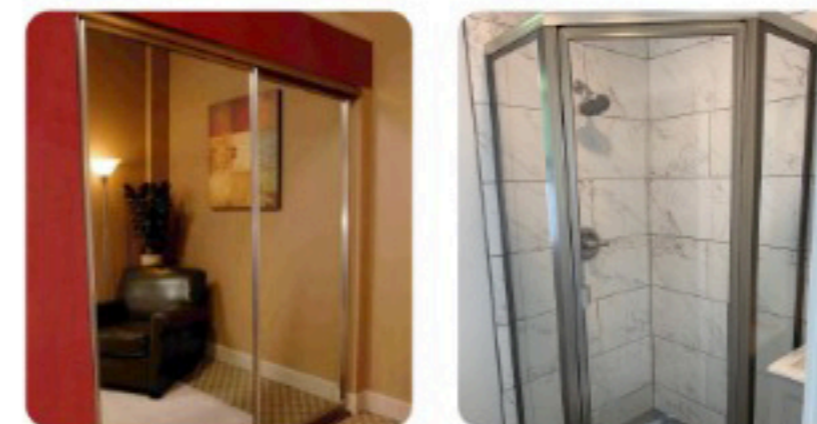

Glass Types



Obscure Rain Delta Frost



Acid Etch Gray Dark Bronze Light

Colors Available



Buy With Confidence

Every ENERGY STAR qualified window or door, is independently certified to perform at levels that meet or exceed strict energy efficiency guidelines set by the U.S. Department of Energy and the State of California.

Deuteronomy 15:10

Give generously to them and do so without a grudging heart; then because of this the Lord your God will bless you in all your work and in everything you put your hand to.

Grid Styles

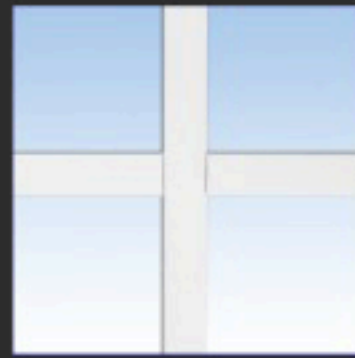

3/4" Flat Grids



1" Sculptured Grids

Grid Options



Colonial



6-Lite



9 - Lite



Victorian

Wood Shutters



Benefits of Low "E3" Glass

Save a significant on your energy bill by replacing old, inefficient windows and sliding doors with energy star vinyl with low "E3" Glass

Keeps you and your home more comfortable, warm in winter, cool in summer.

Low "E3" Glass is like sun screen for your home. Protects your photographs, artwork, furniture, carpets and woodfloors from sun damage.

Guaranteed Work!



Duralite®



1690 W Frontage Rd,
Chula Vista, CA 91911

Direct: (619) 737.9999 | Text: (619) 271.2222

Fax: (619) 271-2222

sales@glahs.com

Business Hours

Mon - Fri: 8:00am - 5:00pm

Saturday: Closed

Sunday: Closed



www.glahs.com



Manufacturer of high quality vinyl windows and doors

www.willerwindows.com

Free Estimates!!
Call, Email, Fax or Walk-ins



We accept all credit cards

